

E660, E760

6 or 7 Digit Counter, Non Reset

Features

- Low Cost, Large Quantity Discounts
- Rugged ABS Case
- Many Voltage Ranges Available
- Long Life
- Compact Size

Description:

The E series incorporates the latest manufacturing technology together with a basic design to achieve high performance over a wide temperature range with very low power consumption. These counters can be mounted by snap-in front flange or rear screw mount.

Applications:

The compact design and competitive pricing of the E660 and E760 make them the ideal counters for almost all counting applications. These electro-mechanical counters will not lose their count during power failures, or from electrical noise. The E660 and E760 are used in:

- Mail equipment
- Photo machines
- Vending machines
- Gaming machines
- Elevators
- Copiers and printers
- Ticket machines
- Laundry machines

Specifications:

Operating Voltage: (+/-10%)

DC: 5,12,24 (1.2W)

Display: Six or seven digit, .110" (2.8mm) high. White on black.

Count speed: 10 CPS standard. 15 CPS optional. 50/50 ratio on/off.

Max. On time: Infinite.

Reset: None.

Termination: UL/CSA wire leads, 13.78"(350mm).

Operating temperature: 23° F to 104°F (-5°C to +40°C).

Storage temperature: 14°F to 122°F (-10°C to +50°C).

Weight: 1 oz. (28.35 grams).

Specials: Many specials available. Consult factory.

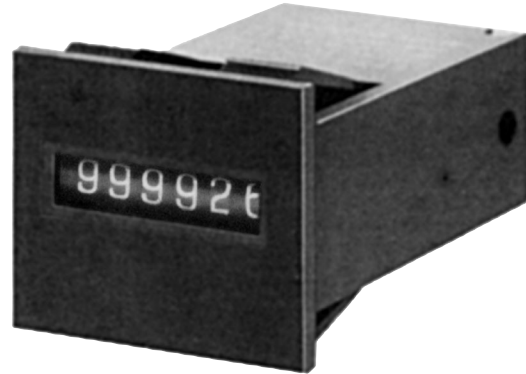

How To Order:

| EXAMPLE: | E660 | A | P | 10 | DC | 12 |
|-------------------------------|---|---|---|----|----|----|
| Series | E660 = 6 Digit Counter E760 = 7 Digit Counter | | | | | |
| Special Order Features | _ = Blank if standard A = Diode across Coil M = M3 Threads | | | | | |
| Mounting | P = Panel Mount R = Rear Mount (4-40) F = Front Mount (4-40) FI = Front Mount (4-40) with inserts RT = Rear Mount (4-40) with Terminal Pins for PCB Mount B = Base Mount K = Rear Mount with 4-40 screw between Terminal Pins | | | | | |
| Count Speed | 10 = 10 CPS (standard) 15 = 15 CPS (optional) 25 = 25 CPS (optional) | | | | | |
| Operating Voltage | DC | | | | | |
| Voltage Level | DC: 5, 12, 24 | | | | | |

Dimensions

Panel Mount

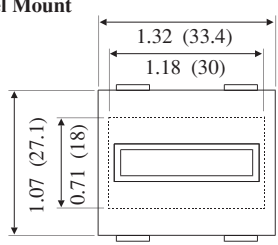

| Panel Thickness | A |
|---------------------|-----------------------|
| 0.04~0.06 (1.0~1.4) | 0.95~0.97 (24.2~24.6) |
| 0.06~0.08 (1.4~2.0) | 0.97~0.98 (24.3~24.7) |

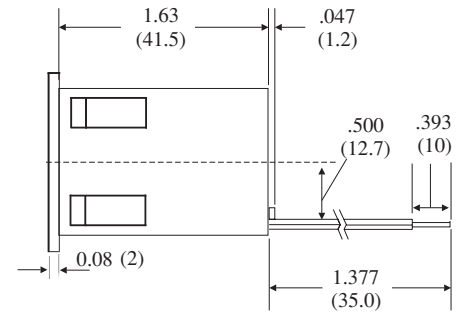
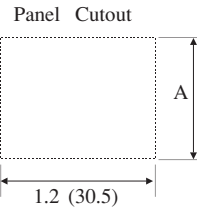

Rear Mount

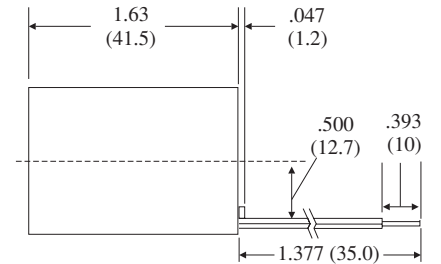
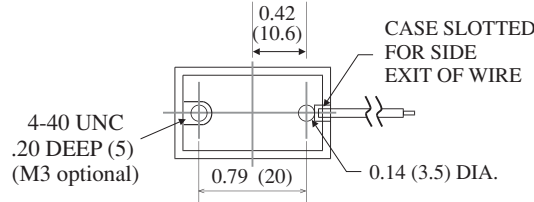
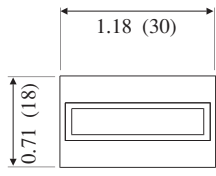

Front Mount

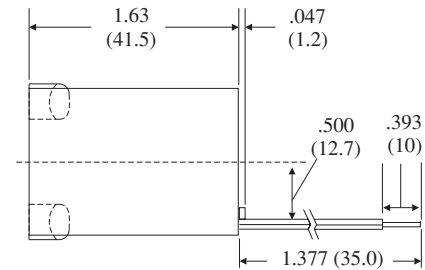
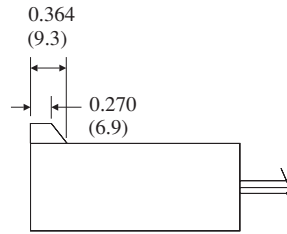
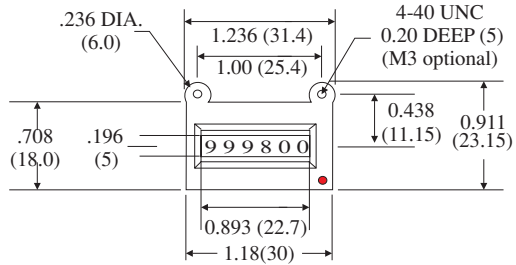

Base Mount

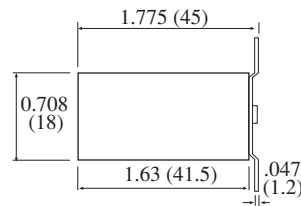
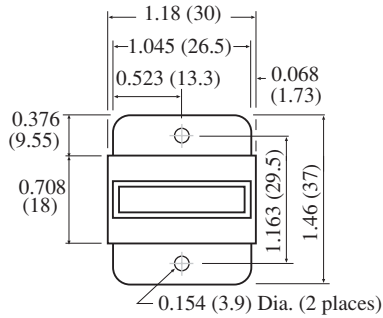

Pin Terminal Type

